

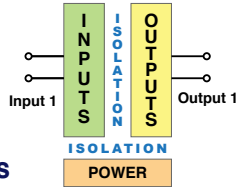

Leopard TL Series Transmitters / Controllers

▶ **Compact, 22.5mm, DIN Rail Mount Transmitter**

▶ **Triple Isolated:** Power to Inputs
Power to Outputs
Inputs to Outputs



▶ **Accepts most common input signals**

- DC - Volts, Amps, mV, mA
- AC - Volts, Amps, mV, mA, Line Frequency
- Load Cell, Pressure, Strain Gauge
- 3 Wire Potentiometer - Position, Resistance
- Temperature - Thermocouple, RTD Pt-100
- Proximity Switch - RPM or Frequency

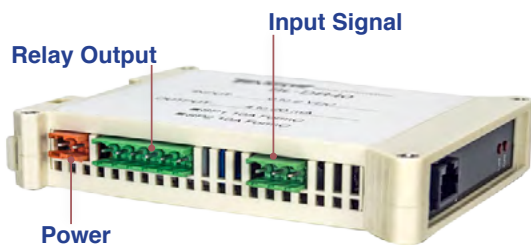

Base Model Number:

- TL..... Standard model with Programmable Scale Factor
- TLF..... Frequency (Input only)
- TLH..... Temperature (Input only)
- TLRPM... RPM (Input only)



Optional Remote Display Programmer
Needed for programming Relays

▶ **Active, isolated analog output. 4-20mA / 0-10V**
(No need of external 24V to power output)

- ▶ **Plug n Play.** Ordered unit is setup to your exact requirements.
- ▶ **Special Functions:** Hysteresis, Delay on Make and Brake.
- ▶ **Dual 9A Form C relays with NO and NC connections available.**
- ▶ **24 VDC Excitation** to power 4-20 mA loops and selectable 5 or 10 VDC to power Strain Gauge and Pressure / Load Cell.
- ▶ **Auto sensing AC/DC power supply** 85-265 VAC / 95-300 VDC or optional 15-48 VAC / 10-72 VDC.
- ▶ **Remote programmer** may be used as a remote display.



POPULAR APPLICATIONS

4-20 mA Isolator with Alarm

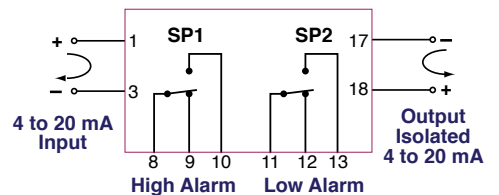

AC Current or AC Voltage with Alarm

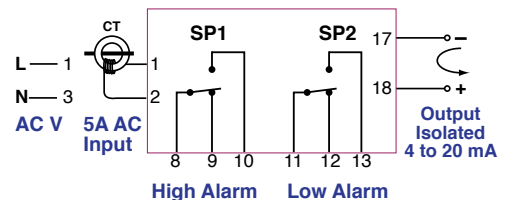

Frequency

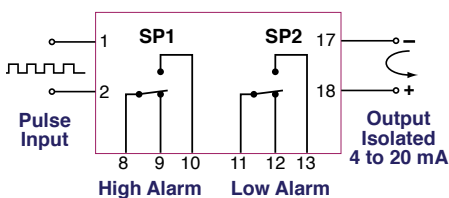

Temperature

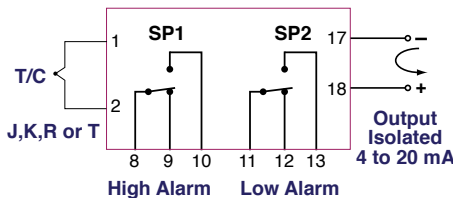

Potentiometer

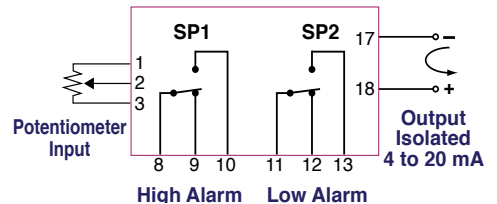

Leopard TL Series Transmitters

ORDERING INFO

*** Selection Required**

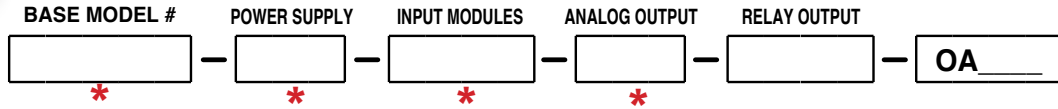

▶ BASE MODEL NUMBER

- TL Standard model with Programmable Scale Factor
- TLF Frequency (Input only)
- TLH Temperature (Input only)
- TLRPM RPM (Input only)

▶ POWER SUPPLY

- PS1 **85-265VAC/95-300VDC**
- PS2 15-48VAC/10-72VDC

▶ INPUT MODULES

Unless otherwise specified Texmate will ship all modules precalibrated with factory preselected ranges and/or scalings as shown in **BOLD** type

For TL and TLPSF Series Transmitter Only

- IA01 . . . AC-Volts Scaled RMS, 200/**300V AC**
- IA02 . . . AC-Volts Scaled RMS, 200mV/**2V/20V AC**
- IA03 . . . AC-mA Scaled RMS, **2/20/200mA AC**
- IA04 . . . AC-Amps Scaled RMS, **0-1 Amp AC (0-100.00)**
- IA05 . . . AC-Amps Scaled RMS, **0-5 Amp AC (0-100.00)**
- IA06 . . . AC-Volts True RMS, 200/**300V AC**
- IA07 . . . AC-Volts True RMS, 200mV/**2V/20V AC**
- IA08 . . . AC-mA True RMS, **2/20/200mA AC**
- IA09 . . . AC-Amps True RMS, **0-1 Amp AC (0-100.00)**
- IA10 . . . AC-Millivolt, Scaled RMS, **100mV AC**
- IA11 . . . AC-Amps True RMS, **0-5 Amp AC (0-100.00)**
- IA12 . . . AC-Millivolt, True RMS, **100mV AC**
- ID01 . . . DC-Volts, **2/20/200V/Custom** w/24V DC Exc
- ID02 . . . DC-Millivolt, 20/50/**100/200mV DC** w/24V DC Exc
- ID03 . . . DC-Milliamp, **2/20/200mA DC** w/24V DC Exc
- ID04 . . . DC-Amps, **5A DC**
- ID05 . . . DC-Volts **2/20/200/Custom V DC** w/Offset and 24V Exc.
- ID07 . . . DC-Milliamp, **2/20/200mA DC** w/Offset and 24V Exc
- ID09 . . . DC-Amps, **1A DC**
- IP01 . . . Process Loop, **4-20mA(0-100.00)**
- IP02 . . . Process Loop, **4-20mA(0-100.00)** w/24VDC Exc
- IP03 . . . Process Input, **1-5V DC(0-100.00)** w/Offset, 24V Exc.
- IP07 . . . Universal Process **2V/5V/10V/20V/200V/2mA/20mA/Custom**
- IR02 . . . 3-Wire Potentiometer 1KΩ min (0-F.S.)
- IR03 . . . Linear Potentiometer, 3-wire, 1KΩ min
- IR05 . . . Resistance 2KΩ
- IS01 . . . Strain Gage 5/10VDC Exc., **20/2mV/V, 4/6-wire**
- IS02 . . . Pressure 5/10VDC Exc., **20/2mV/V, 4/6-wire**
- IS04 . . . Pressure Ext Exc., **20/2mV/V, 4/6-wire**
- IS05 . . . Pressure/Load Cell 20/2mV/V, 5/10V Exc 4-wire
- IS06 . . . Pressure/Load Cell Ext Exc., **20/2mV/V, 4-wire**
- IS07 . . . Pressure 20/2mV/V with High Impedance and External Excitation

*Temperature - For TLH Series Transmitter Only

- IT10 . . . Thermocouple, J/K/R/T, Selectable °C/°F, 1°/0.1°
- IT11 . . . RTD, 100Ω Pt. Selectable 3/4-wire, °C/°F, 1°/0.1°, 385/392
- IT15 . . . RTD, 1000Ω Pt. Selectable 3/4-wire, °C/°F, 1°/0.1°, 385/392

*Frequency - For TLF Series Transmitter Only

- IF05 . . . Frequency 2mV/5V with Excitation
- IF08 . . . Line Frequency

*RPM - For TLRPM Series Transmitter Only

- IF05 . . . Frequency with 24V Excitation

▶ ANALOG OUTPUT

- OIC . . . Isolated 16 Bit Current Output, 4-20mA
- OIV . . . Isolated 16 Bit Voltage Output, 0-10VDC

▶ RELAY OUTPUT

- R11 . . Single 9A Form C Relay
- R12 . . Dual 9A Form C Relays

SPECIAL OPTIONS

▶ SPECIAL OPTIONS

Range Change and Custom Scaling

Customer must specify the input signal range or digital span and the desired display range, or output signal range. Multiple inputs or multiple displays require a separate range change or custom scaling part number and a specified channel for each input or display.

Range Change and calibration to another header selectable standard range CR-CHANGE . . . Range Change from Standard Range shown in **BOLD** type . .

Output - Custom Scaling within standard ranges of analog output. COA-3/3.5/4 . . . Custom scaling of analog output

Short Depth 96x48 Remote Display/Programmer Kit

OP-TL/RDISP . . Remote Display/Programmer w/Cable and Belt clip Carrying Case



CASE DIMENSIONS

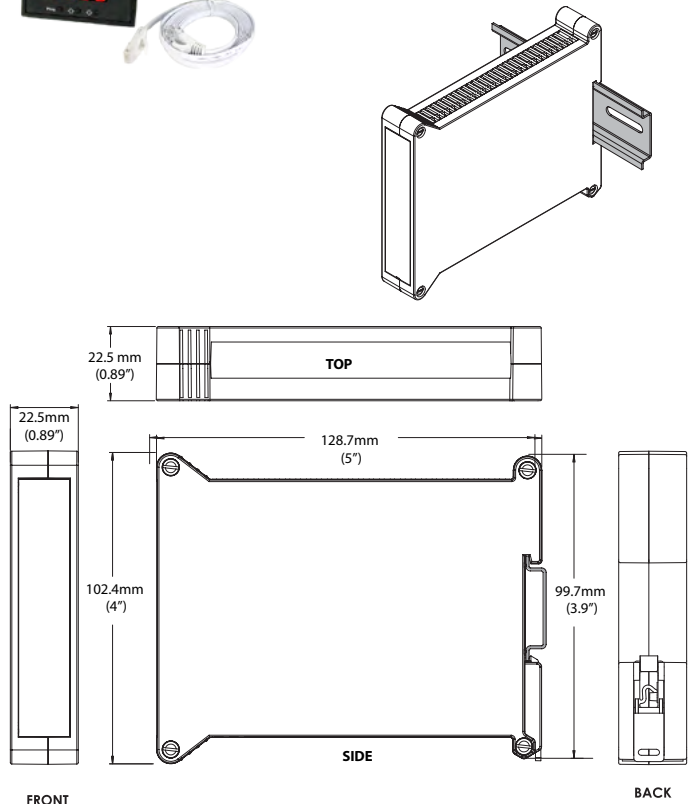

- For ordering info call: 1-800-TEXMATE or 760 598-9899
 - Email: orders@texmate.com • Fax: (760) 598-9828
 - For tech assistance call: (760) 598-9899
- 450 State Place, Escondido, CA 92029